

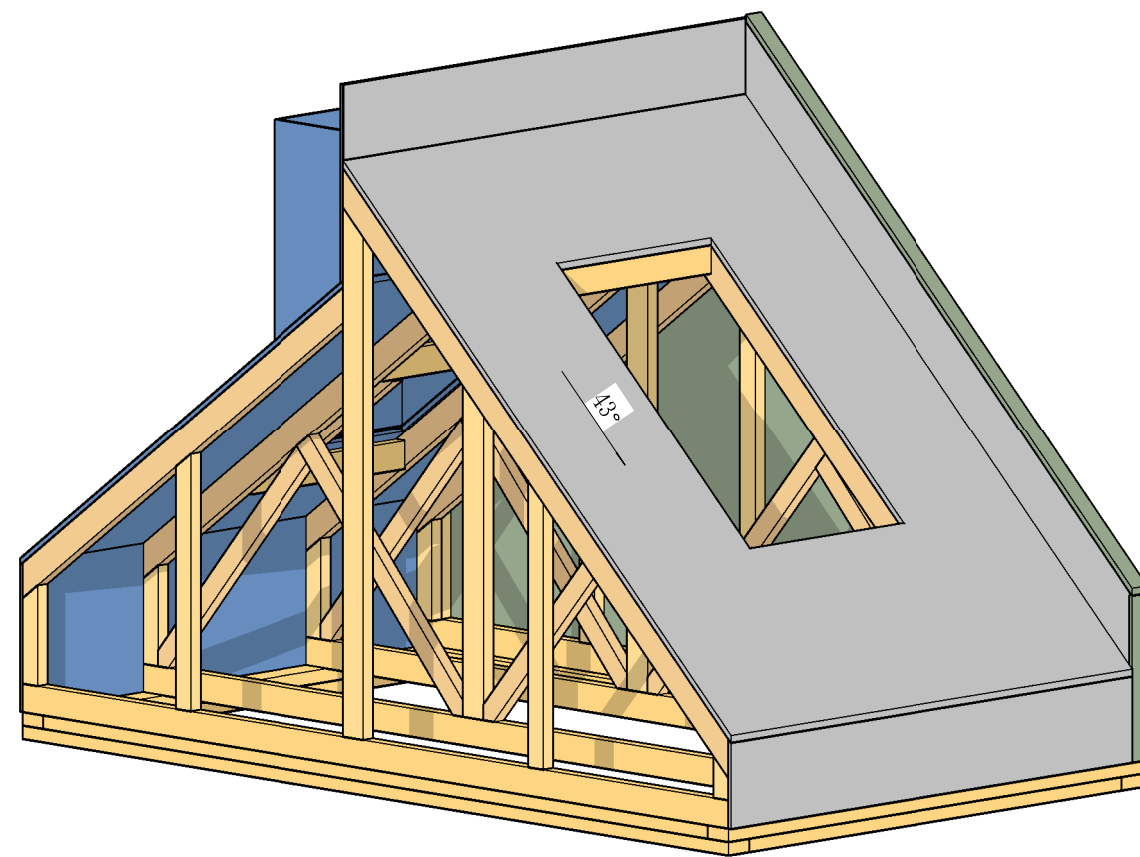

Sheet name:	Plan and sections
Sheet nr:	1
Date:	06.12.2017

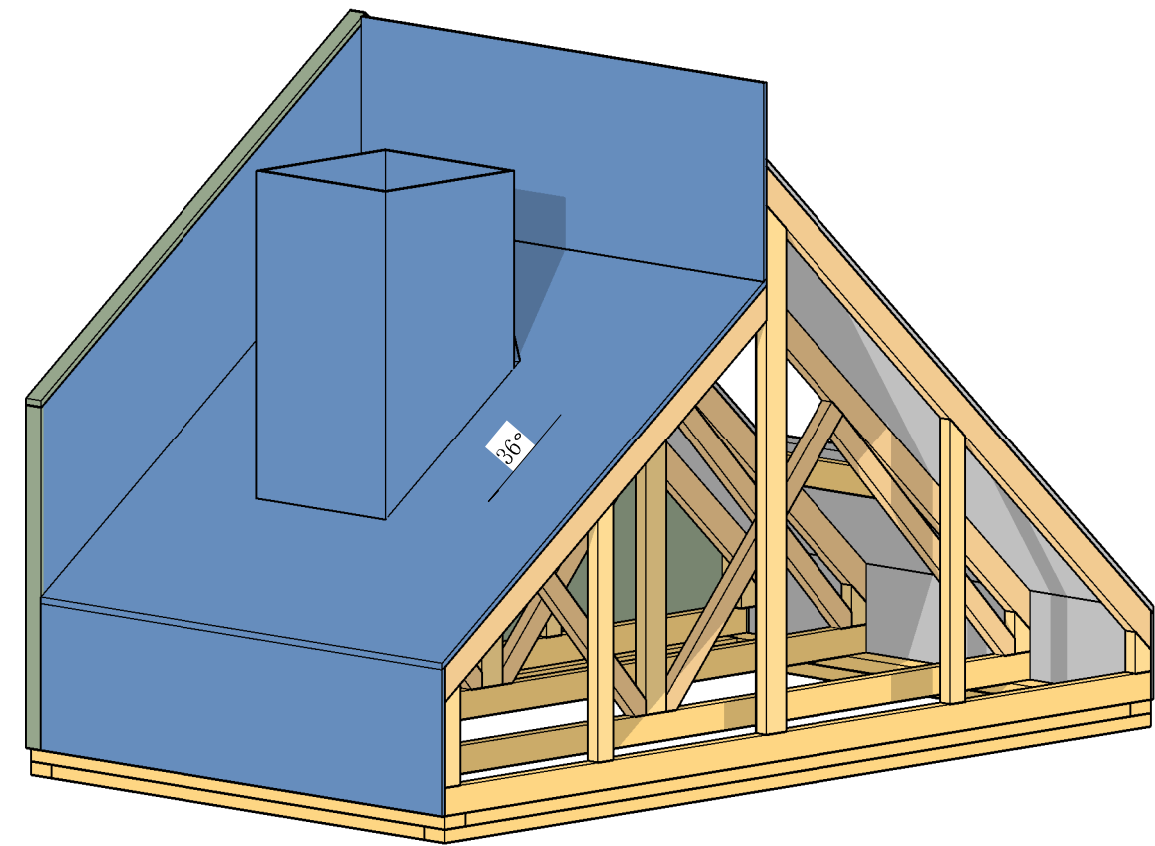

3D view. 1



3D view.2

	
Sheet name:	3D view
Sheet nr:	2
Date:	06.12.2017

1 2 3 4 5 6 7 8

A
B
C
D
E
F

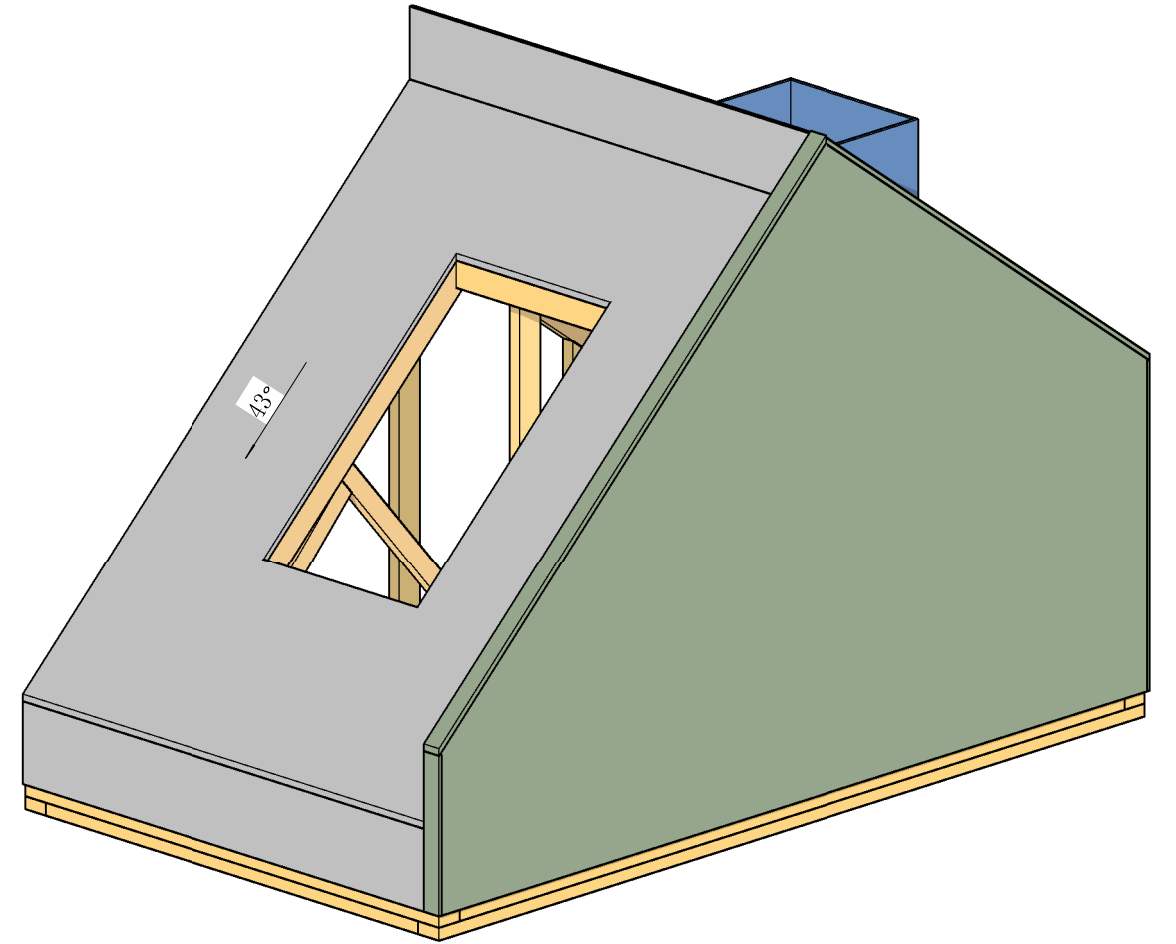
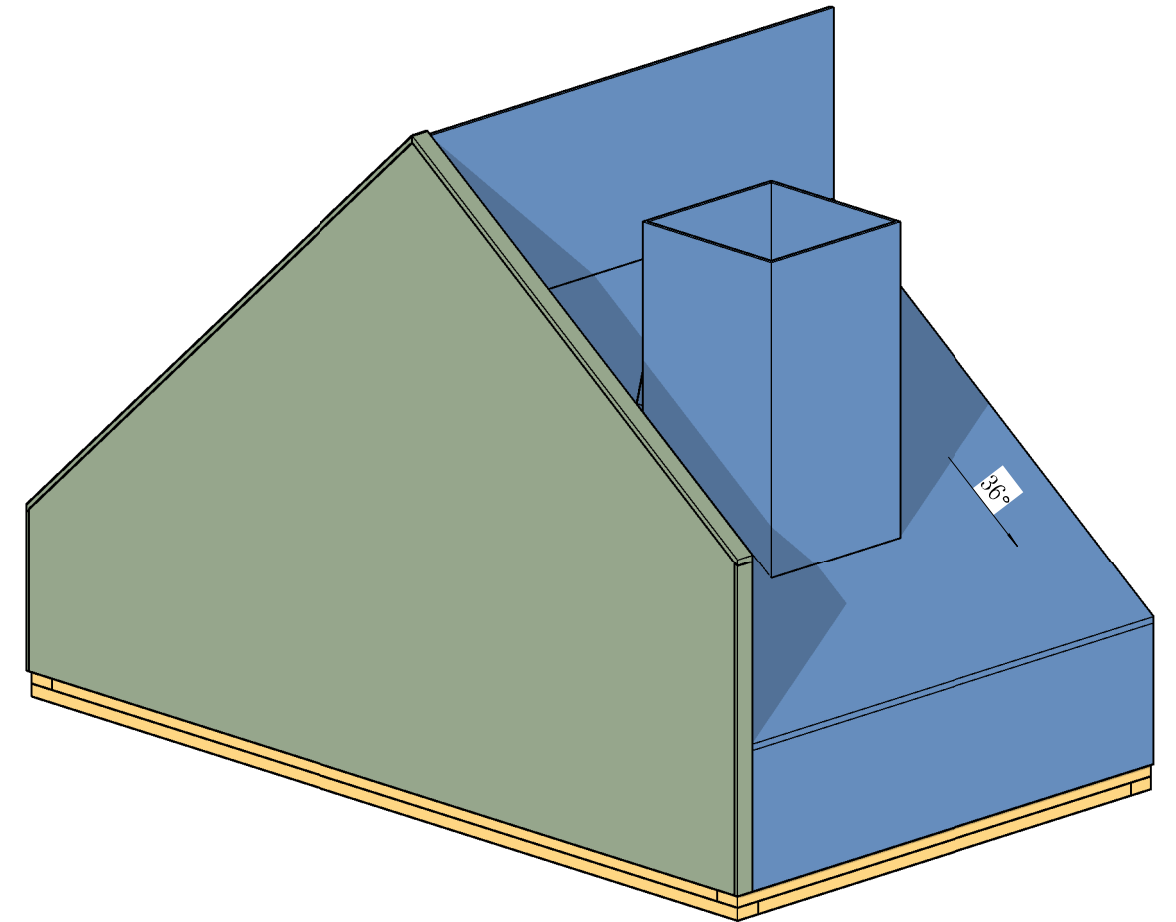

A
B
C
D
E
F



3D view.3

3D view.4

1 2 3 4 5 6 7 8

	
Sheet name:	3D view
Sheet nr:	3
Date:	06.12.2017